

NOTE: ALL MATERIAL COMPLIANT ROHS STANDARD

REVISION INFORMATION			
Rev.	Rev. Date	Modified By	Brief Description

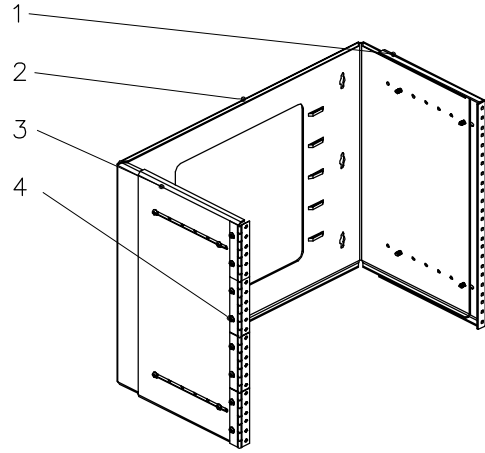

SCALE 1/8

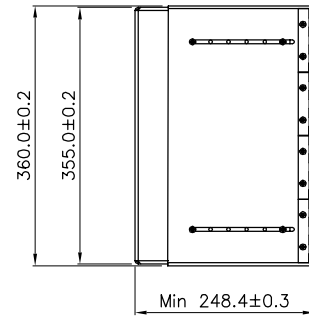

EXTENSIBLE

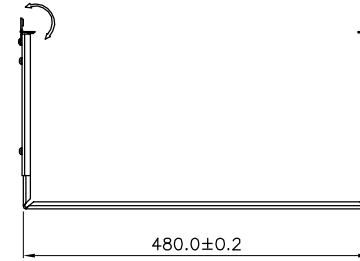
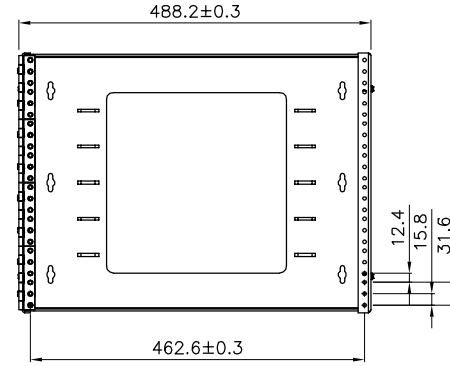
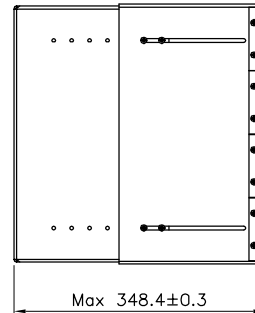

Specification :

Material :

1. Right Slide : SPCC, 2.0 mm thickness with Black(RAL 9005) color painted.
2. Bracket Frame : SPCC, 2.0 mm thickness with Black(RAL 9005) color painted.
3. Left Slide : SPCC, 2.0 mm thickness with Black(RAL 9005) color painted.
4. Screw : M5 x L12.0 mm.



NO.	PART NAME	SPECIFICATION DESCRIPTION	QTY	UNIT
③				
②				
①				

DRAWN BY	DATE: 2012/08/25	DESCRIPTION: 8U Hinged Extendable Wall Mount Bracket, Max 13.5" Depth	
CHECKED BY	SHEET 1 of 1	ITEM NO. 102236	
APPROVED BY	SCALE 1:8	REV. 00	UNIT: mm

