

NOTE: ALL MATERIAL COMPLIANT ROHS STANDARD

REVISION INFORMATION			
Rev.	Rev. Date	Modified By	Brief Description

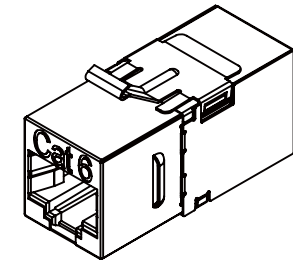
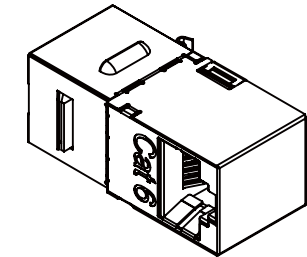
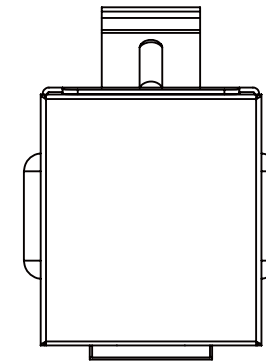
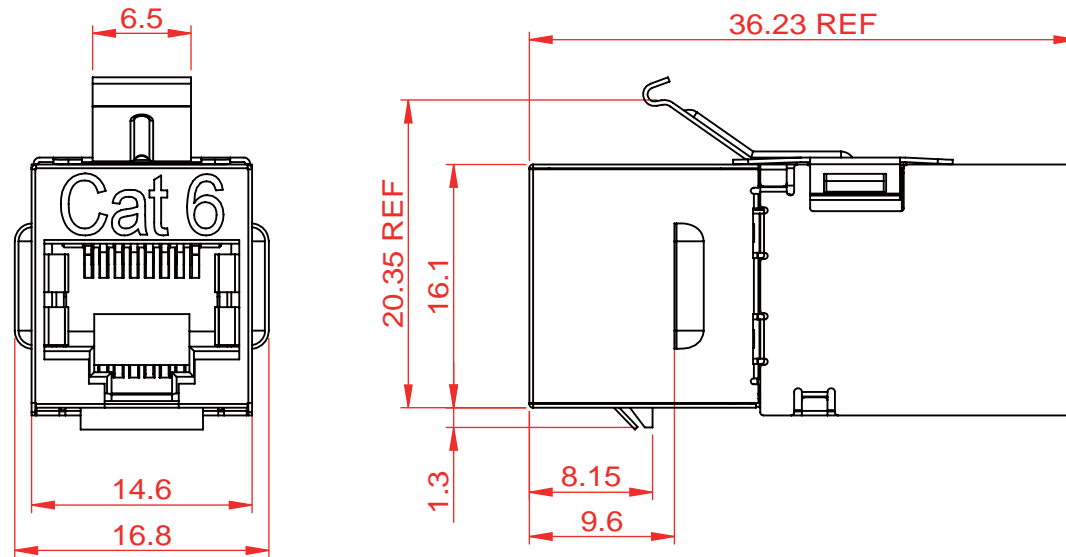

MATERIAL

PANEL : SHIELDED CASE : BRASS,NICKEL PLATED.
 BRACKET : STAINLESS.
 COUPLER HOUSING : ABS,UL94V-0.
 CONTACT HOLDER : ABS,UL94V-0.
 JACK CONTACTS : PHOSPHOR BRONZE,50U" GOLD PLATED.

PHYSICAL CHARACTERISTICS

INSERTION LIFE : 750 MATING CYCLES WITH FCC COMPLIANT 8P PLUG.
 CONTACT FORCE : 100 GRAMS WITH FCC COMPLIANT 8P PLUG.
 PLUG RETENTION FORCE : 11 LBF MIN.
 OPERATING TEMPERATURE RANGE : -10°C TO 60°C.
 STORAGE TEMPERATURE RANGE : -40°C TO 68°C.
 HUMIDITY : 10%~90%RH.

ELECTRICAL

INSULATION RESISTANCE : 500 MΩ.
 DIELECTRIC WITHSTANDING VOLTAGE : 1000 V AC.
 DC CURRENT RATING : 1.5 Amps.
 DC RESISTANCE : 0.1Ω.
 CONTACT RESISTANCE : 20mΩ.

NOTE

① ONLY ACCEPT RJ-45 8P8C PLUG.

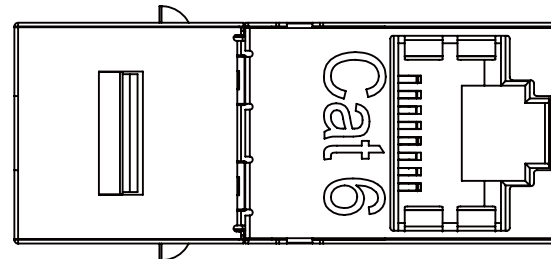

Cat 6



SUGGESTED MOUNTING CUTOUT

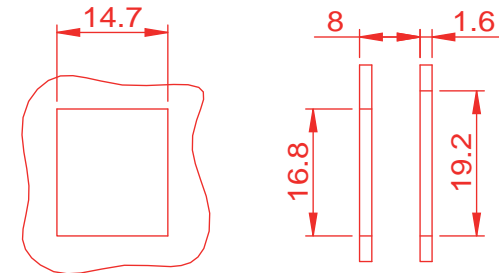

ACCORDING TO : ANSI/TIA-568-C.2
 ISO/IEC 11801 2nd Edition
 IEC 60603-7



NO.	PART NAME	SPECIFICATION DESCRIPTION	QTY	UNIT
③				
②				
①				

Unless specified on the drawing, tolerances are per the follows:
 .x +1
 .x +0.2
 .xx +0.05

DRAWN BY	DATE: 2018/04/27	DESCRIPTION: Cat.6 STP Coupler
CHECKED BY	SHEET 1 of 1	ITEM NO. 102015WT
APPROVED BY	SCALE 1:1	REV. 00 UNIT:mm

NOTE: CARTON MATERIAL MUST BE A=A

REVISION INFORMATION			
Rev.	Rev. Date	Modified By	Brief Description

Inner Box Dimensions	Q'ty pre Inner Box	Q'ty pre Outerr Box	Outer Box Dimensions	CUFT
348*233*206MM	250	4	485*361*436MM	2.9



Inner Box



Outer Box

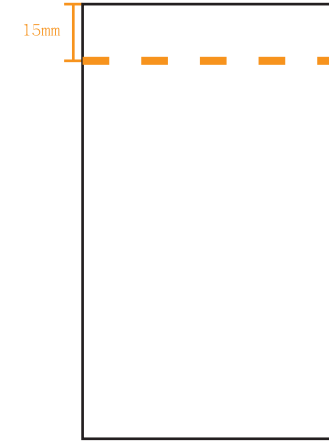

Size: W70*H115 (mm)

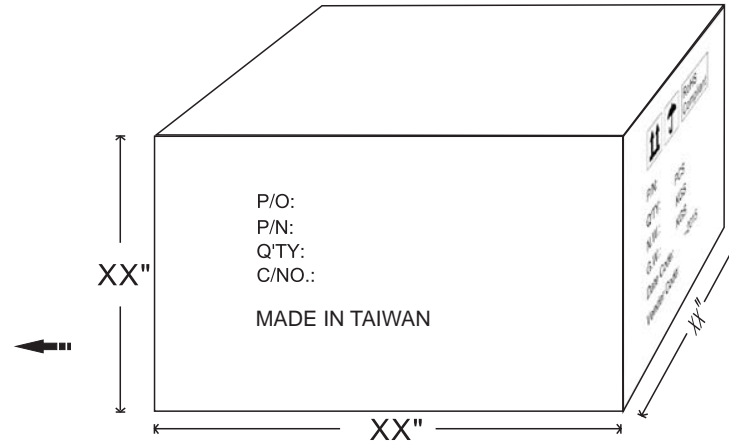
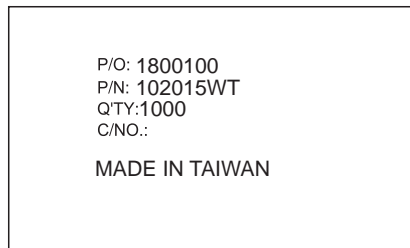

Carton Size: 48cm x 37.5cm x 45cm
 Carton Quantity: 1000PCS
 Carton Weight: 9.8kg

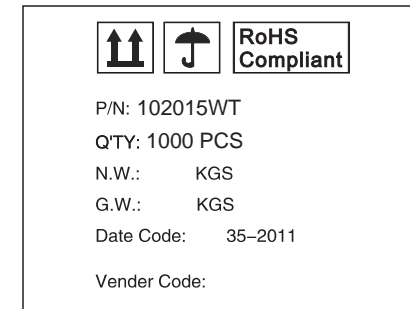

DRAWN BY	DATE: 2018/04/27	DESCRIPTION: Cat.6 STP Coupler	
CHECKED BY	SHEET 1of2	ITEM NO. 102015WT	
APPROVED BY	SCALE 1: 1	REV. 00	UNIT:mm