

NOTE: ALL MATERIAL COMPLIANT ROHS STANDARD

REVISION INFORMATION			
Rev.	Rev. Date	Modified By	Brief Description

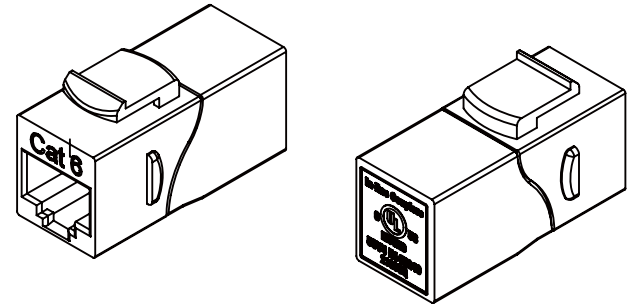
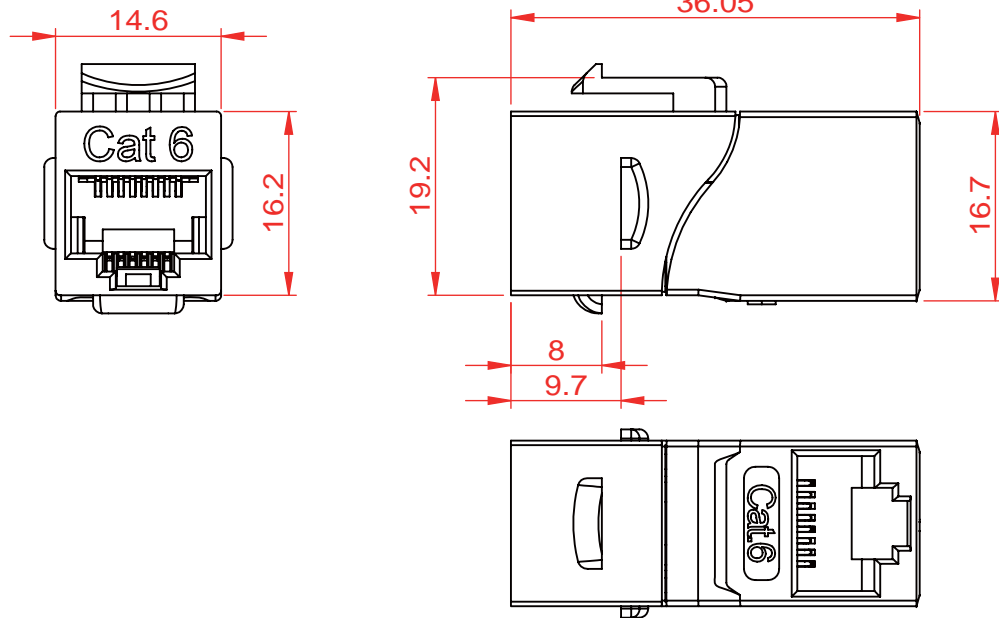

ACCORDING TO : ANSI/TIA-568-C.2
ISO/IEC 11801 2nd Edition
IEC 60603-7

SUGGESTED MOUNTING CUTOUT

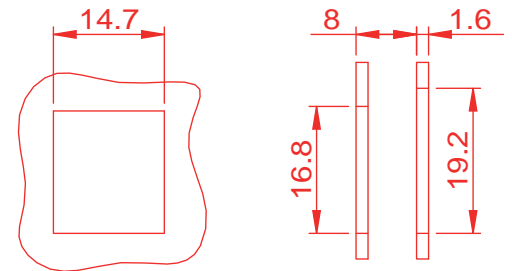

MATERIAL

COUPLER HOUSING : PC,UL94V-0.
CONTACT HOLDER : ABS,UL94V-0.
JACK CONTACTS : PHOSPHOR BRONZE,50U" GOLD PLATED.

PHYSICAL CHARACTERISTICS

INSERTION LIFE : 750 MATING CYCLES WITH FCC COMPLIANT 8P PLUG.
CONTACT FORCE : 100 GRAMS WITH FCC COMPLIANT 8P PLUG.
PLUG RETENTION FORCE : 11 LBF MIN.
OPERATING TEMPERATURE RANGE : -10°C TO 60°C.
STORAGE TEMPERATURE RANGE : -40°C TO 68°C.
HUMIDITY : 10%-90%RH.

ELECTRICAL

INSULATION RESISTANCE : 500 MΩ.
DIELECTRIC WITHSTANDING VOLTAGE : 1000 V AC.
DC CURRENT RATING : 1.5 Amps.
DC RESISTANCE : 0.1Ω.
CONTACT RESISTANCE : 20mΩ.

NOTE

- WILL NOT SUPPORT CHANNEL SHORTER THAN 15M.
- ONLY ACCEPT RJ-45 8P8C PLUG.



Cat 6



COMMUNICATION
CIRCUIT ACCESSORIES



NO.	PART NAME	SPECIFICATION DESCRIPTION	QT'Y	UNIT
③				
②				
①				

Unless specified on the drawing, tolerances are per the follows:
· +1
.x +0.2
.xx +0.05

DRAWN BY	DATE: 2018/04/27	DESCRIPTION: Cat.6 Coupler
CHECKED BY	SHEET 1of1	ITEM NO. 102013WT
APPROVED BY	SCALE 1: 1	REV. 00 UNIT:mm

NOTE: CARTON MATERIAL MUST BE A=A

REVISION INFORMATION			
Rev.	Rev. Date	Modified By	Brief Description

Inner Box Dimensions	Q'ty pre Inner Box	Q'ty pre Outerr Box	Outer Box Dimensions	CUFT
348*233*206MM	250	4	485*361*436MM	2.9



Inner Box



Outer Box

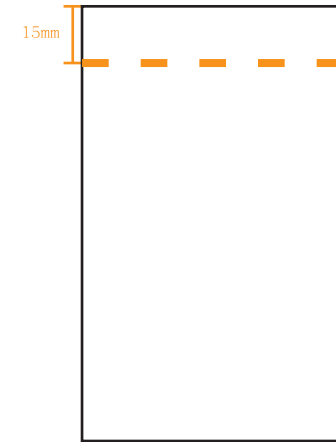

Size: W70*H115 (mm)

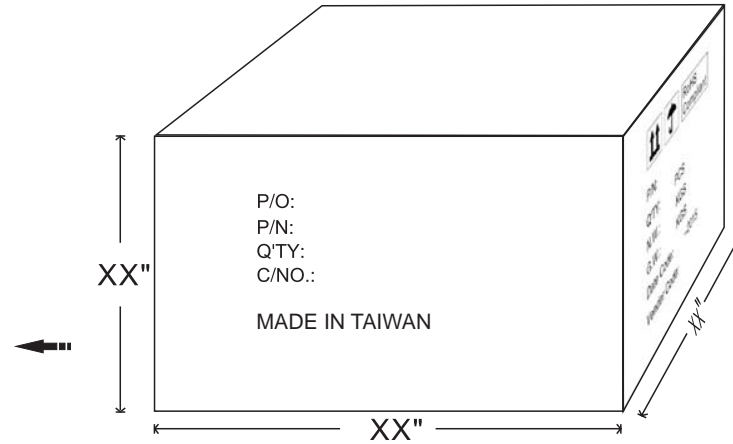
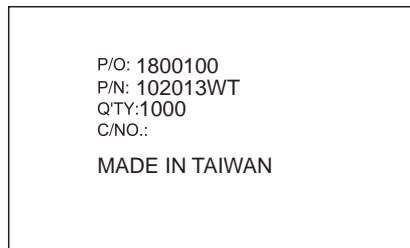

Carton Size: 48cm x 37.5cm x 45cm
 Carton Quantity: 1000PCS
 Carton Weight: 9.8kg

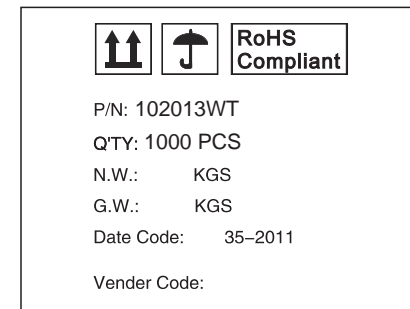

DRAWN BY	DATE: 2018/04/27	DESCRIPTION: Cat.6 Coupler
CHECKED BY	SHEET 1 of 2	ITEM NO. 102013WT
APPROVED BY	SCALE 1:1	REV. 00
		UNIT:mm