

NOTE: ALL MATERIAL COMPLIANT ROHS STANDARD

REVISION INFORMATION

Rev.	Rev. Date	Modified By	Brief Description

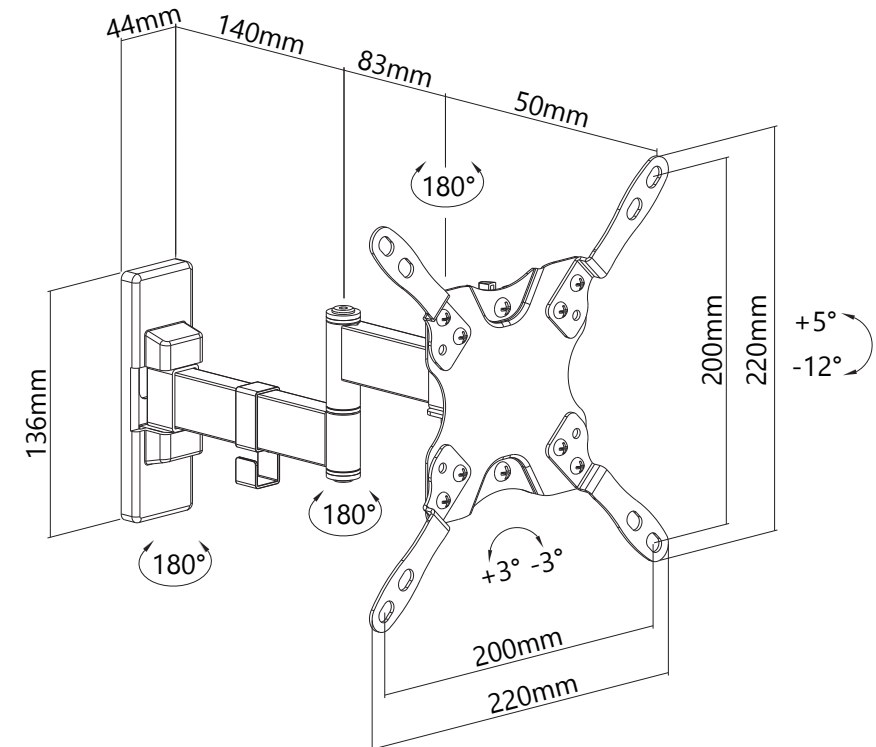
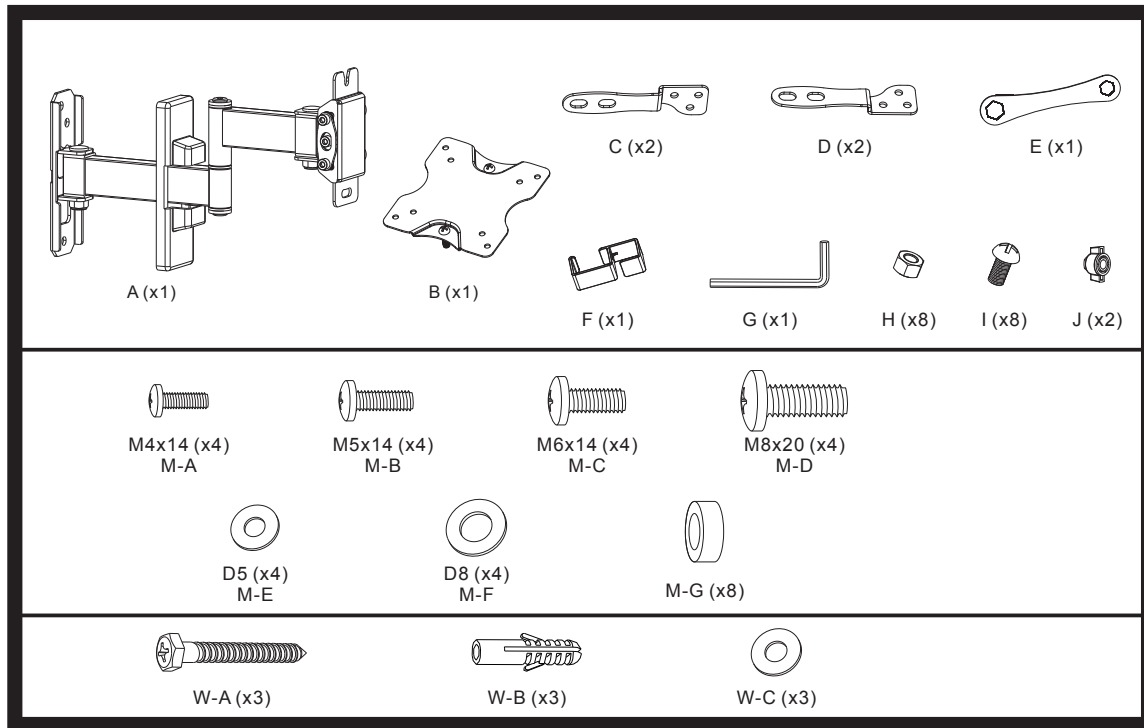

NO.	PART NAME	SPECIFICATION DESCRIPTION	QT'Y	UNIT
③				
②				
①				

Unless specified on the drawing, tolerances are per the follows:
 . +1
 .x +0.2
 .xx +0.05

DRAWN BY	DATE: 2021/1/29	DESCRIPTION: Full Motion TV Wall Mount LDA21-222	
CHECKED BY	SHEET 1of1	ITEM NO. 502681BK	
APPROVED BY	SCALE 1:1	REV. 00	UNIT:mm