

NOTE:ALL MATERIAL COMPLIANT ROHS STANDARD

REVISION INFORMATION

Rev.	Rev. Date	Modified By	Brief Description

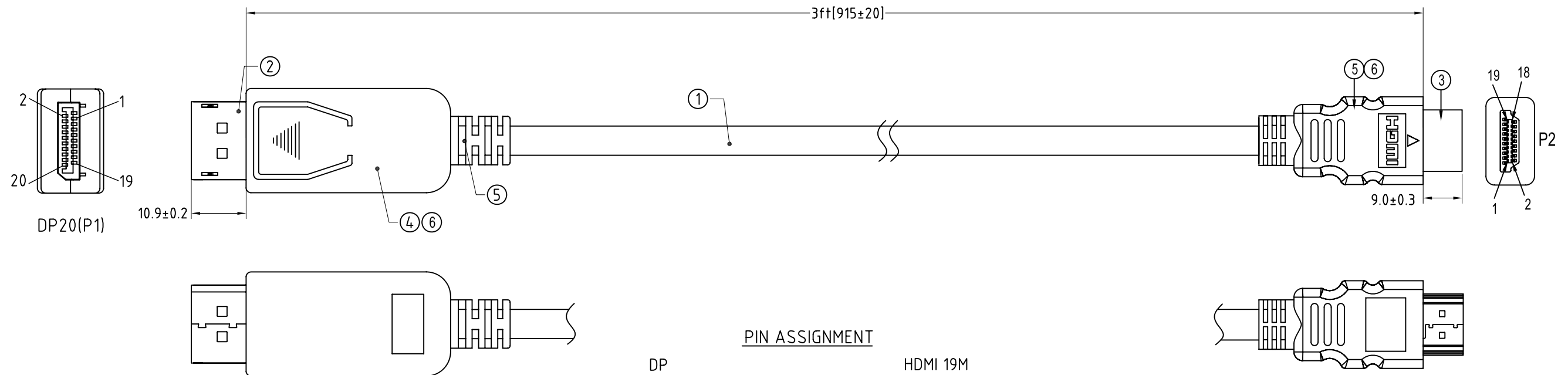

PIN ASSIGNMENT

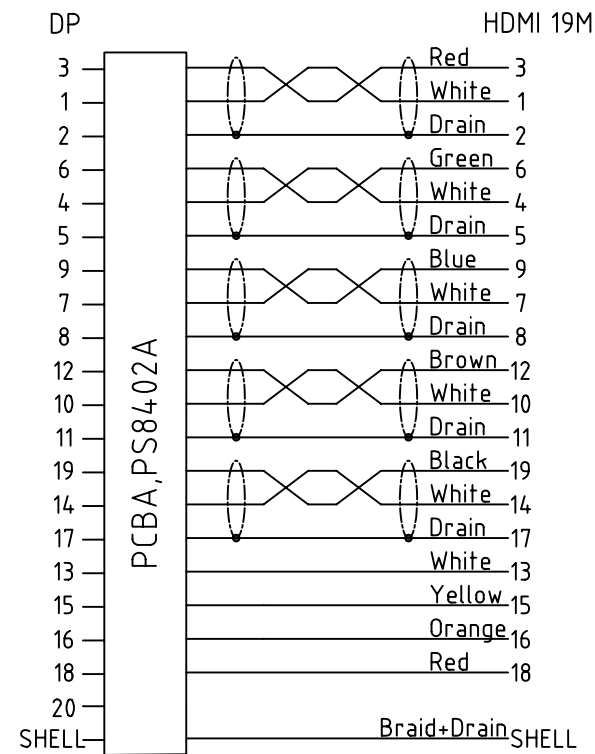

Wire Details

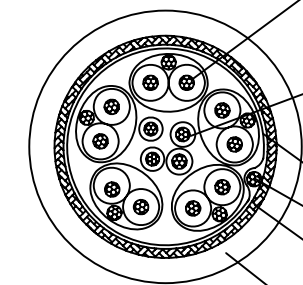

- (30AWG×1P+Drain+Al+Mylar)/5C
Conductor:CCS 7/0.10mm
Insulation:FM-PE+Skin
- 30AWG/4C
Conductor:CCS 7/0.10mm
Insulation:HD-PE
- Al.Mylar
- Drain:Bare Copper 7/0.10mm
- Braid: Al-Mg,16/4/0.12mm
- Jacket: PVC; Color: Black
Ø6.0mm

Electrical character:

- 100% Open/short/Intermittent testing
- Withstanding voltage:AC/DC 300V AT 10ms.
- Insulation resistance:10M Ohm(min)
- Residual operating current:
 - a.<1.M=0.5mA; b.1.0~2.0M=1.0mA;
 - c.2.0~3.0M=2.0mA; d.3.0~5.0M=3.0mA;
 - e.5.0~10M=5.0mA; f.10~15M=7.0mA;
- Conductive resistance:See the TABLE A
- 100% 1080P, 3D, 4Kx2K@30Hz testing

NO.	PART NAME	SPECIFICATION DESCRIPTION	QTY	UNIT
①	Cable	UL20276 (30#CCS*1P+D+A+M)*5+30#CCS*4C+A+D+B(16/4/0.12,Al-Mg)+PVC,Black,OD:6.0mm		
②	Conn	HDMI Male,Pin G/F,Black Insulation,Shell(G/F Plated),Solder type		
③	Conn	DisplayPort Male,Pin G/F,Black Insulation,Shell(G/F Plated),Solder type PCBA:PS8402A		
④	Shell	Display port 20 Pin Shell,ABS,Black,Twinset Type		
⑤	Innermold	PE,Low density		
⑥	Overmold	PVC,45Pa,Black		

Unless specified on the drawing, tolerances are per the follows:

.	+1
.x	+0.2
.xx	+0.05

DRAWN BY	DATE: 2019/06/10	DESCRIPTION: DisplayPort M to HDMI AM cable,30#
CHECKED BY	SHEET 1of2	ITEM NO. 181438
APPROVED BY	SCALE None	REV. 0.0

UNIT:mm

NOTE: CARTON MATERIAL MUST BE A=A

REVISION INFORMATION			
Rev.	Rev. Date	Modified By	Brief Description

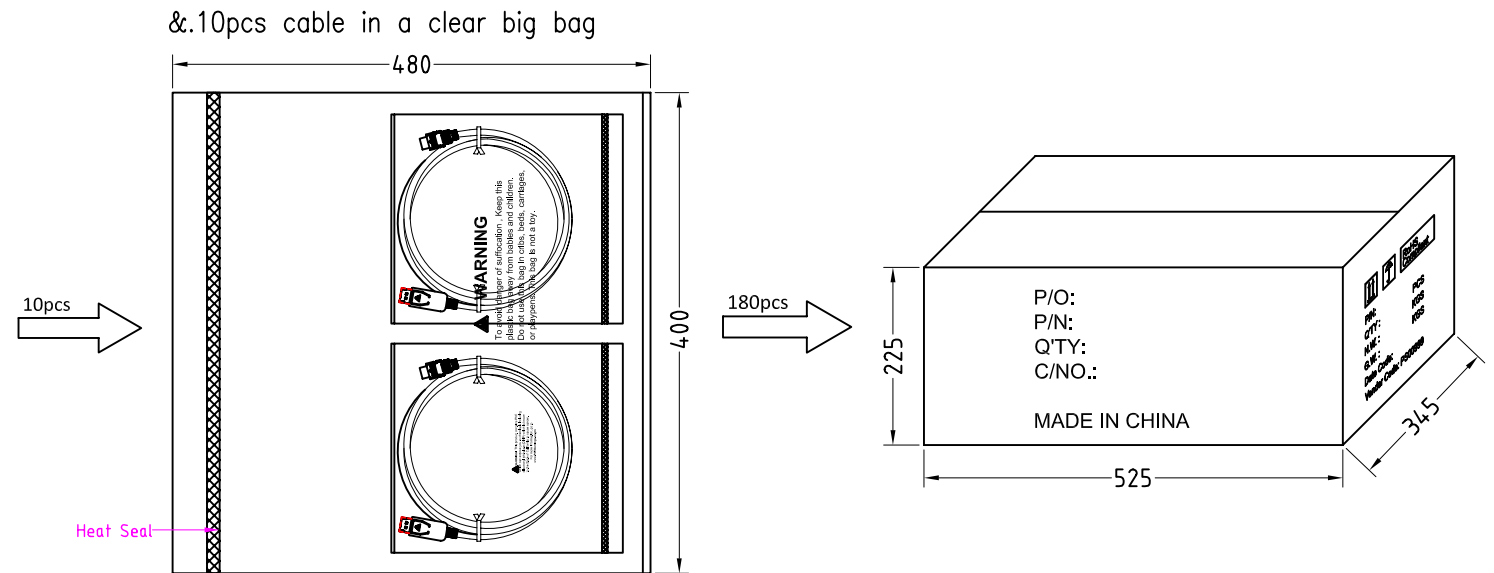
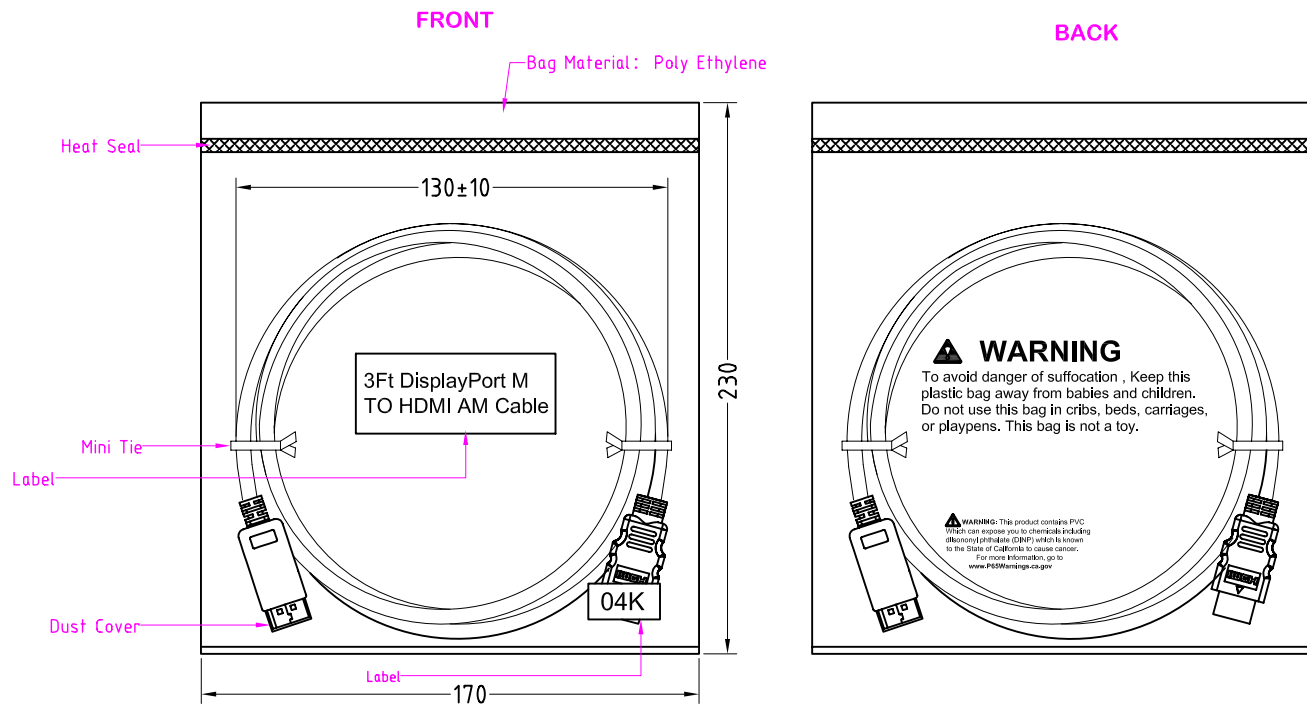

MAIN MARK

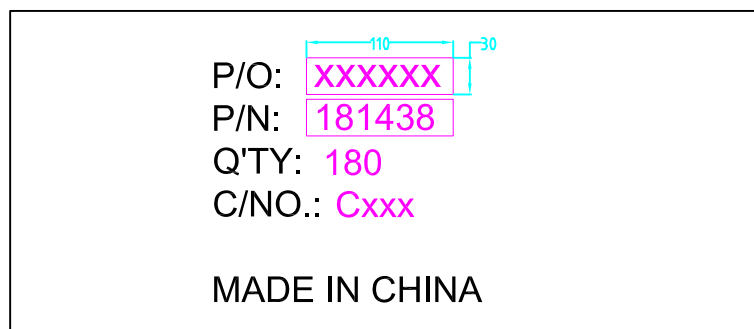

Label:
Size: 50 x 20 mm

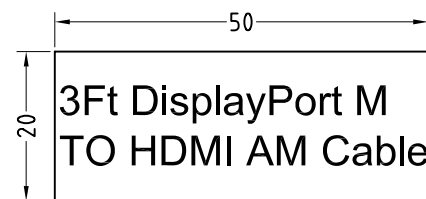

Label:
Size: 10 x 5 mm

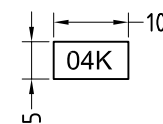

Packing Instruction:

1. First of all, protect the connector with dust covers, coil the cable (see attached). Secure the cable with cable tie, and then pack each cable with an individual PE bag, 10 pcs cable in a clear big bag. The label is attached to the PE bag.
2. Seal the PE bag with heat sealing machine.
3. Use a waterproof bag to pack the products before going into master carton. Make sure each individual cable is staggered and positioned tidily. A paperboard is needed in both the bottom and the top of the products.
4. See shipping mark on the left.

SIDE MARK

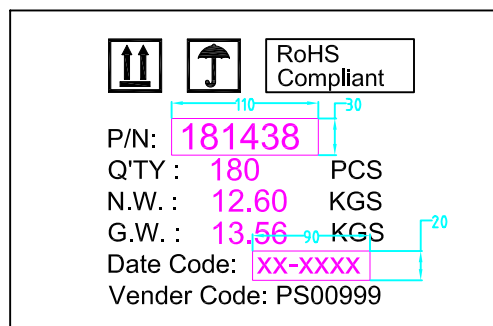

Carton Size: 20.67"(L)*13.58"(W)*8.86"(H)
Carton Quantity: 180 pcs
Carton Weight: 28.90LBS

BESTLINK NETWORK			
DRAWN BY	DATE: 2016/06/10	DESCRIPTION: DisplayPort M to HDMI AM cable, 30#	
CHECKED BY	SHEET 2of2	ITEM NO. 181438	
APPROVED BY	SCALE None	REV. 0.0	UNIT: mm