

NOTE: ALL MATERIAL COMPLIANT ROHS STANDARD

REVISION INFORMATION			
Rev.	Rev. Date	Modified By	Brief Description

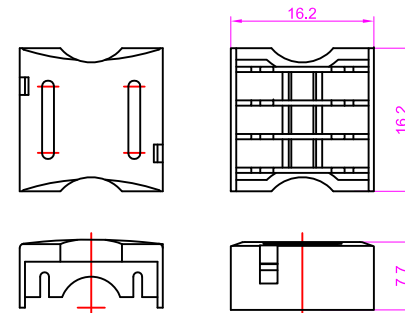

IDC Cap

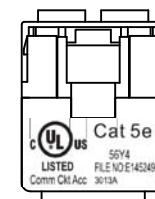
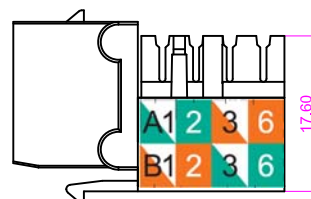
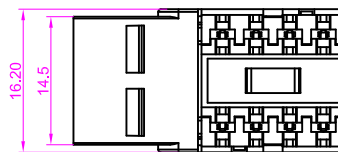
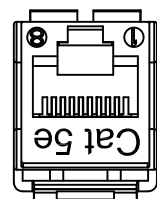
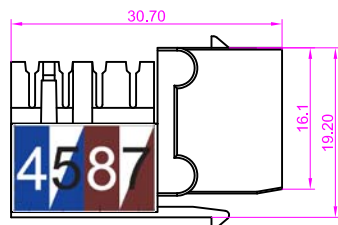
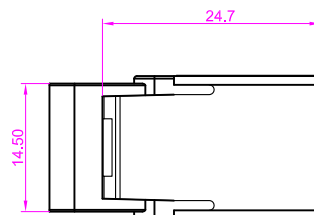

Physical Specification

Jack housing: ABS high-impact UL94V-0 thermoplastic
 Spring wire: Phosphor Bronze C5210R-H, t=0.3mm Plating 120u" Matte Tin over 60u" Nickel undercoat, besides Plating 50u" Gold over the plated surface on contact area.
 IDC housing: Polycarbonate resin high-impact UL94V-0 thermoplastic
 IDC contact: Phosphor Bronze C5191R-H, t=0.4mm, 200u" Tin over 100u" Nickel undercoat
 Insertion Life: 750 mating cycles with FCC compliant RJ-45 plug
 Contact force: 100 grams with FCC compliant RJ-45 plug
 Plug retention force: 11 lbf min
 Durability: 200 termination cycles
 Contact compatibility: Accommodates 22 to 26 AWG solid/24 AWG stranded
 Operating Temperature Range: -10°C to 60°C
 Storage Temperature Range: -40°C to 68°C
 Humidity: 10%~90%RH

Electrical

Insulation resistance: 500 M Ω
 Dielectric withstanding voltage: 1000 V
 DC current rating: 1.5 Amps
 DC resistance: 0.1 Ω
 Contact resistance: 20m Ω

Part Number	COLOUR	QTY	G. W (LBS)	G. W (KGS)
1	101602BL PANTONE 3015C	1000	24.3	11
2	101602GN PANTONE 7726C	1000	24.3	11
3	101602GY PANTONE C001Gray4c	1000	24.3	11
4	101602IV PANTONE 7501C	1000	24.3	11
5	101602OR PANTONE 2023C	1000	24.3	11
6	101602RD PANTONE 1925C	1000	24.3	11
7	101602WT RAL 9016	1000	24.3	11
8	101602BK PANTONE 433C	1000	24.3	11
9	101602YW PANTONE 1225C	1000	24.3	11

ACCORDING TO ANSI/TIA-568-C.2
 REQUIREMENTS
 C5e CHANNEL COMPLIANT

Cat 5e

56Y4
 E145249



COMMUNICATION
 CIRCUIT ACCESSORIES

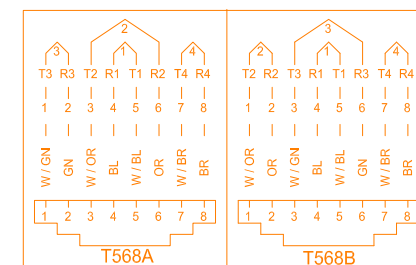

NO.	PART NAME	SPECIFICATION DESCRIPTION	QTY	UNIT
③				
②				
①				

DRAWN BY	WLL	DATE:	2017/08/11
CHECKED BY		SHEET	1 of 1
APPROVED BY		SCALE	1:2
DESCRIPTION: Cat.5E RJ45 110 Type Keystone Jack		ITEM NO.	101602XX
REV.	01	UNIT:	mm

NOTE: CARTON MATERIAL MUST BE A=A

REVISION INFORMATION

Rev.	Rev. Date	Modified By	Brief Description

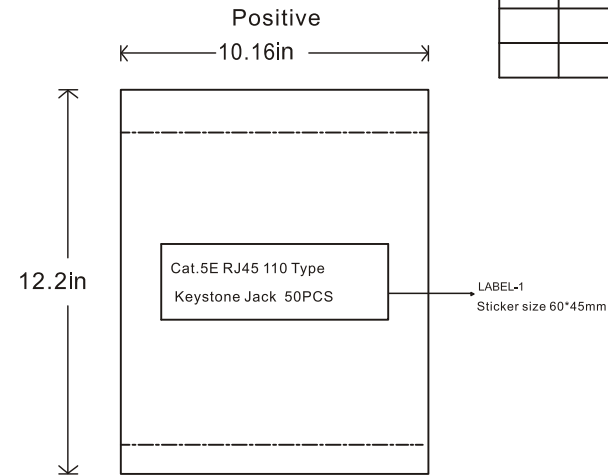
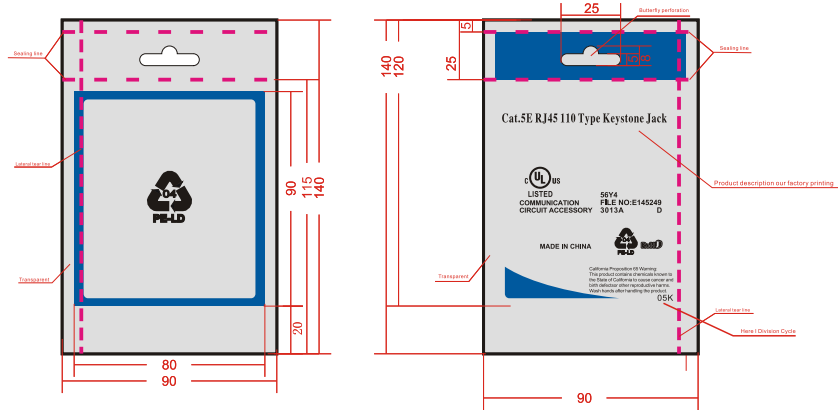

Inside the box

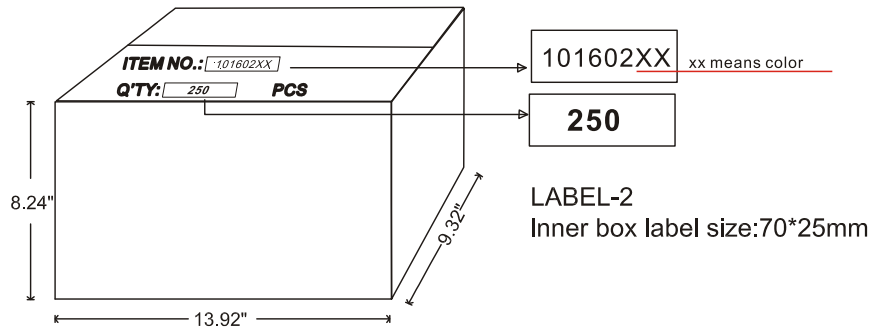

Outside the box

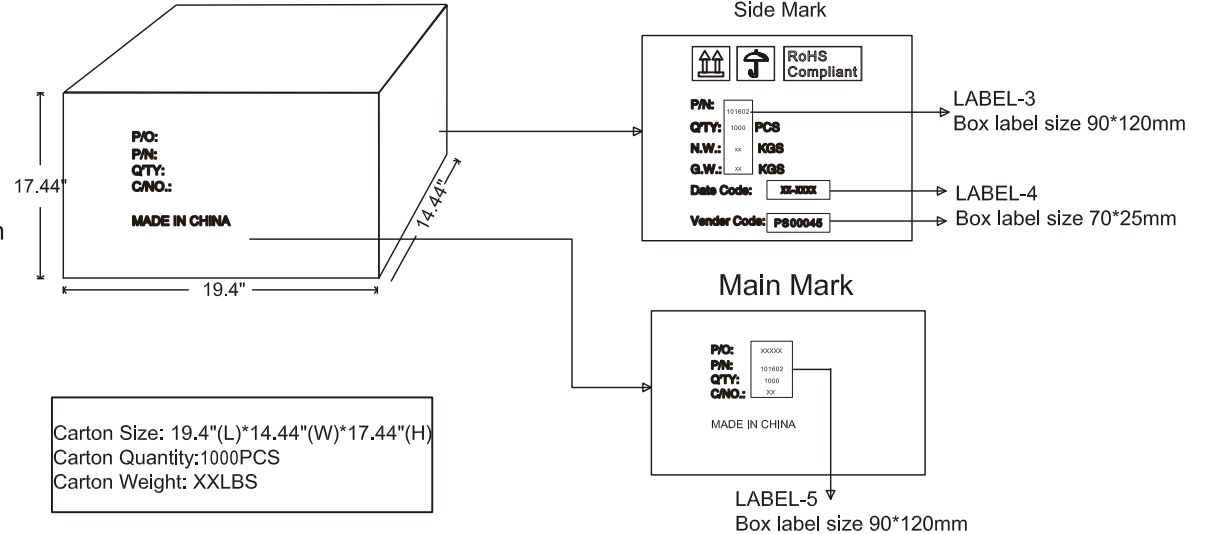

Unit package
Size: 13.92"(L)*9.32"(W)*8.24"(H)
Weight: XXLBS

Carton Size: 19.4"(L)*14.44"(W)*17.44"(H)
Carton Quantity: 1000PCS
Carton Weight: XXLBS



NO.	PART NAME	SPECIFICATION DESCRIPTION	QTY	UNIT
③				
②				
①				

Unless specified on the drawing, tolerances are per the follows:
 .x +1
 .xx +0.2
 .xxx +0.05

DRAWN BY	DATE: 2017/08/04	DESCRIPTION: Cat.5E RJ45 110 Type Keystone Jack
CHECKED BY	SHEET 1of2	ITEM NO. 101602XX <u>xx means color</u>
APPROVED BY	SCALE 1:1	REV. 00 UNIT: mm