

VERSION INFORMATION			
Rev.	Rev. Date	Modified By	Brief Description

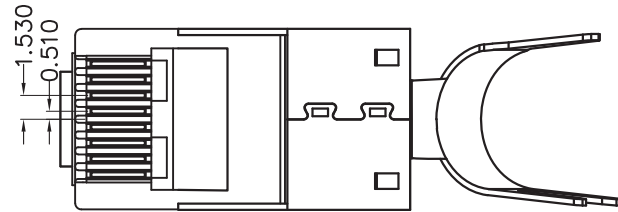
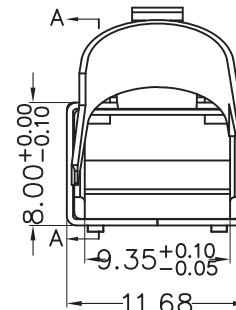
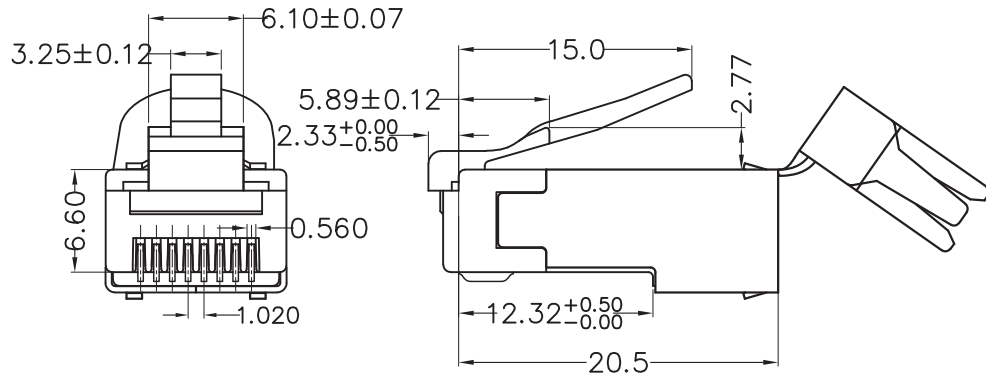
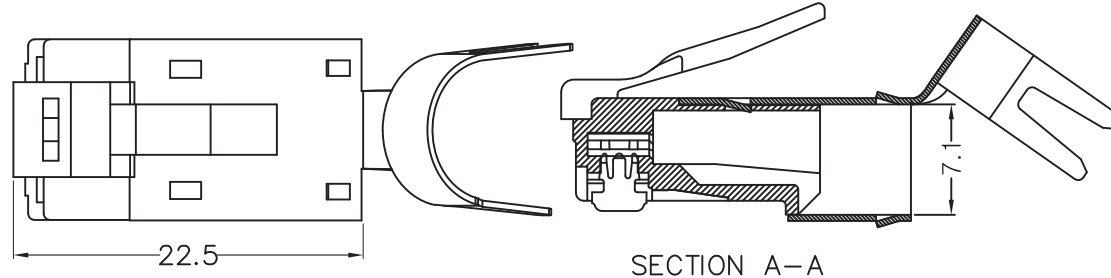

NOTES:

1. Operation Temperature: -40°C ~ +85°C.
2. Electrical Characteristics:
 - 2.1 > Rated Current : 125V AC, 1.5A @ 25°C.
 - 2.2 > Contact Resistance : 20mΩ Max.
 - 2.3 > Insulation Resistance: 500MΩ Min, 100V DC/min.
 - 2.4 > Voltage Proof: 1000V AC/1 minute no breakdown
3. Mechanical Characteristics:
 - 3.1 > Insertion Force & Withdrawal Force : 30N Max.
 - 3.2 > Durability: 750 cycles Min.
4. Environmental compliance:
 - 4.1 > the products are compliant with the RoHS, and REACH etc.

1	Modular Plug	Shell	1PCS	Square hole	Au: G/F" <input type="checkbox"/> 1u" <input type="checkbox"/> 3u" <input type="checkbox"/> Ni: 80u" <input checked="" type="checkbox"/>	Brass <input checked="" type="checkbox"/> Spcc <input type="checkbox"/>
		Contacts	8PCS	2 Prongs <input type="checkbox"/> 3 Prongs <input checked="" type="checkbox"/>	G/F" <input type="checkbox"/> 1u" <input type="checkbox"/> 3u" <input type="checkbox"/> 6u" <input type="checkbox"/> 15u" <input type="checkbox"/> 30u" <input type="checkbox"/> 50u" <input checked="" type="checkbox"/> other <input type="checkbox"/>	Brass <input checked="" type="checkbox"/> Phosphor copper <input type="checkbox"/>
		Housing	1PC	Transparent PC	94V-2 <input checked="" type="checkbox"/> 94V-0 <input type="checkbox"/>	
NO.	NAME	QTY	DESCRIPTION		MATERIAL	

DRAWN BY FW	DATE: 2026/01/21	DESCRIPTION: RJ45 plug with tail clamp for CAT6A 24AWG Armored Cable 50pack Jar
CHECKED BY ACE	SHEET 1 of 3	ITEM NO. 101414
APPROVED BY	SCALE 1:1	REC. 00 UNIT: mm

VERSION INFORMATION			
Rev.	Rev. Date	Modified By	Brief Description

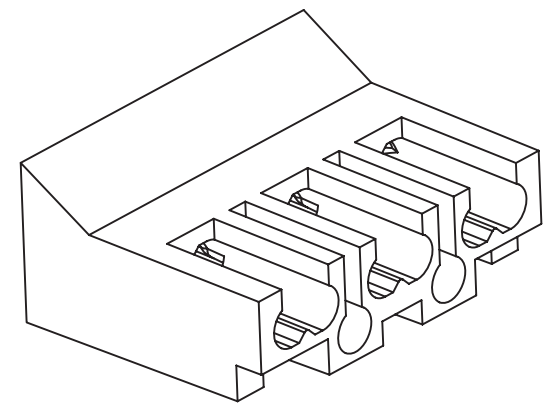
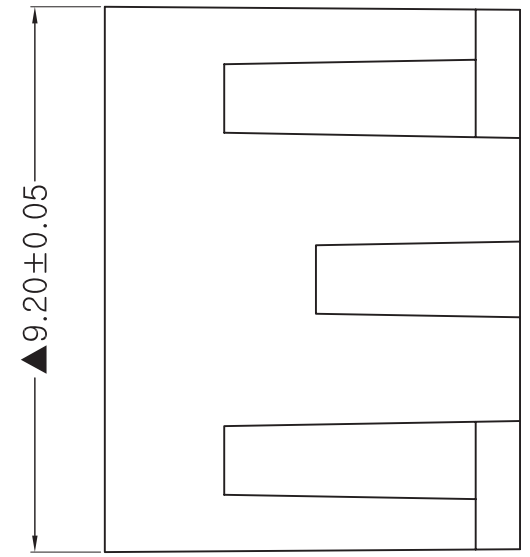
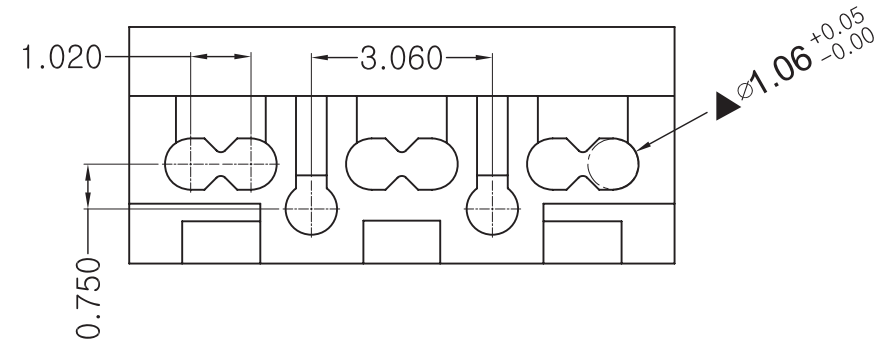
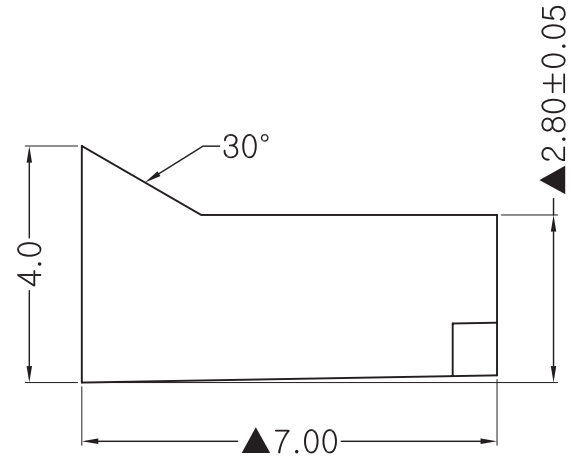

			
DRAWN BY FW	DATE: 2026/01/21	DESCRIPTION: RJ45 plug with tail clamp for CAT6A 24AWG Armored Cable 50pack Jar	
CHECKED BY ACE	SHEET 2 of 3	ITEM NO. 101414	
APPROVED BY	SCALE 1:1	REC. 00	UNIT: mm 