

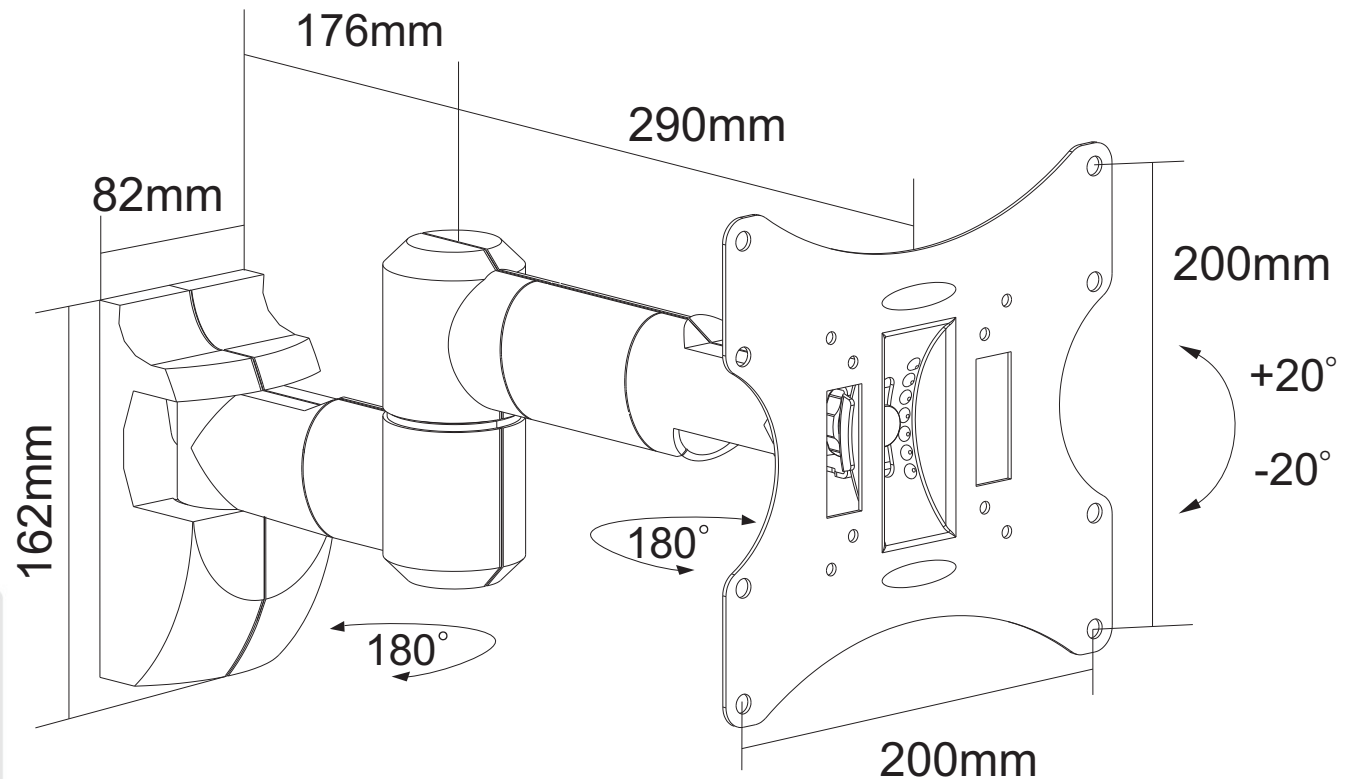















NOTE: ALL MATERIAL COMPLIANT ROHS STANDARD



REVISION INFORMATION			
Rev.	Rev. Date	Modified By	Brief Description



**Package M**

				
M4x10 (x4) M-A	M5x10 (x4) M-B	M6x10 (x4) M-C	M8x15 (x4) M-D	D4 washer (x4) M-E
				
D5 washer (x4) M-F	D6 washer (x4) M-G	D8 washer (x5) M-H	ø13.5xø5.5x3.2 (x4) M-I	M8 (x1) M-J
				
M8 (x2) M-K	M8x20 (x1) M-L	M8x50 (x1) M-M	M8 (x1) M-N	washer (x1) M-O

**Package W**

		
ST6.3x55 (x6) W-A	concrete anchor (x6) W-B	D6 washer (x6) W-C



DRAWN BY	DATE: 2011/12/31	DESCRIPTION: LCD-503A
CHECKED BY	SHEET 1 of 1	ITEM NO. 502719BK
APPROVED BY	SCALE 1:1	REV. 00
	UNIT: mm	

NO.	PART NAME	SPECIFICATION DESCRIPTION	QTY	UNIT
③				
②				
①				